

INTEGRATED AMPLIFIER



SEPARATE AMPLIFIER



ANALOG PLAYER



DIGITAL PLAYER



NeoClassico II



PHONO AMPLIFIER



VACUUM TUBE AMPLIFIER



LUXMAN's Legacy

The listener deserves heart-felt joy when pursuing natural, uncolored audio reproduction. This has been our philosophy for over 95 years since our company was founded in 1925.

Good sound enriches your life.

Enjoy a comforting environment as you become one with the music.



Integrated Amplifier	p3-p4
Control Amplifier	p5
Stereo Power Amplifier	
Vacuum Tube Control Amplifier	p5-p6
Vacuum Tube Stereo Power Amplifier	
Vacuum Tube Integrated Amplifier	p6
Vacuum Tube Compact Disc Player	
Analog Player	p7
Phono Amplifier	

Super Audio CD Player	p8
Compact Disc Player	
Neo Classico II	p9
Selector	p10
Cable	p11
Accessories	

INTEGRATED AMPLIFIER

L-595A Special Edition Pure A

NEW



The L-595ASE is a gem of an integrated amplifier, standing proudly as our 95th anniversary model, with a limited production run of 300 units. Recalling our best-selling model from the 90's, the L-570, which made a name for itself as a famous solid-state amplifier. The L-595ASE is a special edition model which revives that appearance, sound quality and image after 30 years. It is outstanding among audio components, while retaining simple operability and featuring beautiful exterior details, such as an aluminum direct selection button and indicator, the volume level indicator light and a bold counterbore around the volume knob. The sophisticated design provides a luxurious feel. The amplifier section is equipped with ODNF-u, which supports fresh and dense tonality with an overwhelming amount of musical detail. The New LECUA1000 electronically controlled attenuator facilitates smooth volume control. It is a special model that realizes memorable Luxman design and a sound full of musicality.

SPECIFICATIONS

Rated output	30 W+30 W (8 Ω) / 60 W+60 W (4 Ω)
Input sensitivity / impedance	PHONO (MM) 2.5 mV / 47 kΩ, PHONO (MC) 0.3 mV / 100 Ω, LINE 180 mV / 47 kΩ
Total harmonic distortion	0.007 % (1 kHz / 8 Ω), 0.06 % (20 Hz to 20 kHz / 8 Ω)
S/N ratio	LINE 105 dB or more
Frequency response	LINE 20 Hz to 100 kHz (within -3 dB)
Power consumption	330 W, 230 W (no signal), 0.4 W (at standby)
Dimensions	440 (W) x 193 (H) x 462 (D) mm
Weight	29.0 kg

INTEGRATED AMPLIFIER

L-509X



The L-509X incorporates the features of both a high-quality separate amplifier and a high-performance integrated amplifier into one product. It is equipped with many desirable features such as the New LECUA 1000, a discretely configured buffer circuit in the output stage of the pre-amplifier circuit, ODNF (Only Distortion Negative Feedback), our original amplifier feedback circuit, and a power supply with independent left and right channel filter capacitors. The top panel has a beautiful hair-line finish and the LED-lit analogue level meters add to the elegant and stylish appearance.

SPECIFICATIONS

Rated output	120 W+120 W (8 Ω) / 220 W+220 W (4 Ω)
Input sensitivity / impedance	PHONO (MM) 2.5 mV / 47 kΩ, PHONO (MC) 0.3 mV / 100 Ω, LINE 180 mV / 47 kΩ
Total harmonic distortion	0.007 % (1 kHz / 8 Ω), 0.06 % (20 Hz to 20 kHz / 8 Ω)
S/N ratio	LINE 105 dB or more
Frequency response	LINE 20 Hz to 100 kHz (within -3 dB)
Power consumption	380 W, 150 W (no signal), 0.5 W (at standby)
Dimensions	440 (W) x 193 (H) x 463 (D) mm
Weight	29.3 kg

The New LECUA* 1000 —

That realizes the integration of the volume control mechanism and the amplifier circuit

In 2005, the "LECUA1000", a composite system of an electronically controlled fixed resistance switching attenuator and an amplifier circuit, was installed in our flagship control amplifier, the C-1000f, and overturned the conventional concept of volume control functions. Eight years later, for the C-900u control amplifier, in order to further upgrade this system and improve quality, we developed the "New LECUA 1000" which adopted LUXMAN's original amplification feedback circuit ODNF for the amplifier circuitry. Since then, it has been incorporated in many of our amplifier products, realizing the ultimate solution to volume control design that no longer requires the attenuator and amplifier to be considered as separate circuit blocks.

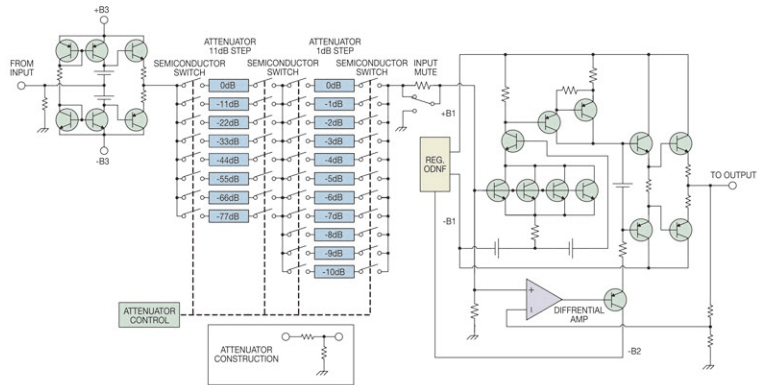

C-900u volume control system block diagram

ODNF* —

Original amplifying feedback circuit

LUXMAN's main amplifier products use our unique ODNF circuitry that achieves both high initial slew rate and impressive bandwidth. The advantages of NFB (negative feedback) are low distortion and frequency band sensitivity, retaining the characteristics of a non-feedback amplifier with swift reaction speed and natural tone. With ODNF4.0 installed in our current main products, such as the M-900u and L-509X, distortion detection accuracy is improved by triple parallelization the first error detection stage. By reducing the amount of feedback to only the distorted elements of the musical signal, we achieve negligible distortion at high frequencies and low volumes, accurately reproducing detailed musical information. The expressive power of dynamics is further increased and the emotion impact of music is depicted with great detail and density.

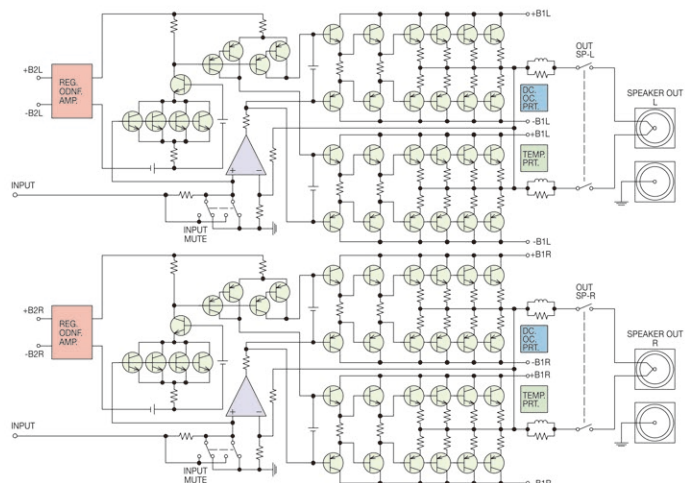

M-900u power output system block diagram

*LECUA : Luxman Electronically Controlled Ultimate Attenuator
*ODNF : Only Distortion Negative Feedback

INTEGRATED AMPLIFIER

L-590AX II Pure A



The L-590AX Mark II draws upon LUXMAN's decades of experience in amplifier design to deliver an exquisite combination of rich sonic expression, fine detail, wide bandwidth and dynamic gusto. In addition to adopting the latest version 4.0 of our original, high quality ODNF feedback circuit, it features independent left and right channel filter capacitors in the power section, a preamp section containing our latest New LECUA 1000 attenuator and discrete buffer circuits. As our class A integrated amplifier, this model provides supreme audio playback satisfaction, completing a component system by combining convenience and quality at the highest level.

SPECIFICATIONS

Rated output	30 W+30 W (8 Ω) / 60 W+60 W (4 Ω)
Input sensitivity / impedance	PHONO (MM) 2.5 mV / 47 kΩ, PHONO (MC) 0.3 mV / 100 Ω, LINE 180 mV / 47 kΩ
Total harmonic distortion	0.005 % (1 kHz / 8 Ω), 0.02 % (20 Hz to 20 kHz / 8 Ω)
S/N ratio	LINE 105 dB or more
Frequency response	LINE 20 Hz to 100 kHz (within -3 dB)
Power consumption	330 W, 260 W (no signal), 0.5 W (at standby)
Dimensions	440 (W) x 193 (H) x 463 (D) mm
Weight	28.4 kg

INTEGRATED AMPLIFIER

L-507uX II



The L-507uX Mark II integrated amplifier earns its Mark II status by having an improved S/N ratio, achieving great spatial expression and overwhelming power. Our New LECUA 1000 enables the volume to be adjusted smoothly and finely over 88 steps thereby minimizing the deterioration of sound quality. Our version 4.0 ODNF system enhances accuracy in distortion detection and elimination. A triple-parallel push-pull output stage achieves complete output linearity with 110 Watts per channel at 8Ω and 210 Watts per channel at 4Ω.

SPECIFICATIONS

Rated output	110 W+110 W (8 Ω) / 210 W+210 W (4 Ω)
Input sensitivity / impedance	PHONO (MM) 2.5 mV / 47 kΩ, PHONO (MC) 0.3 mV / 100 Ω, LINE 180 mV / 47 kΩ
Total harmonic distortion	0.007 % (1 kHz / 8 Ω), 0.08 % (20 Hz to 20 kHz / 8 Ω)
S/N ratio	LINE 105 dB or more
Frequency response	LINE 20 Hz to 100 kHz (within -3 dB)
Power consumption	350 W, 86 W (no signal), 0.4 W (at standby)
Dimensions	440 (W) x 178 (H) x 454 (D) mm
Weight	25.0 kg

INTEGRATED AMPLIFIER

L-550AX II Pure A



The L-550AX Mark II is the successor to the L-550AX, which was launched in 2011. The Mark II makes its debut, featuring our high-precision, electronically controlled attenuator, New LECUA 1000, and the latest version of our proprietary high quality feedback circuit, ODNF4.0, both of which are used in LUXMAN's top-of-the-range amplifiers. We made huge steps forward whilst developing our flagship class A integrated amplifier, the L-590AX Mark II, and the essence of its expressive power was distilled and poured into this model's design to provide the dense expression characteristics particular to pure class A amplifiers and more detailed reproduction of the low range.

SPECIFICATIONS

Rated output	20 W+20 W (8 Ω) / 40 W+40 W (4 Ω)
Input sensitivity / impedance	PHONO (MM) 2.5 mV / 47 kΩ, PHONO (MC) 0.3 mV / 100 Ω, LINE 180 mV / 47 kΩ
Total harmonic distortion	0.007 % (1 kHz / 8 Ω), 0.02 % (20 Hz to 20 kHz / 8 Ω)
S/N ratio	LINE 105 dB or more
Frequency response	LINE 20 Hz to 100 kHz (within -3 dB)
Power consumption	230 W, 170 W (no signal), 0.5 W (at standby)
Dimensions	440 (W) x 178 (H) x 454 (D) mm
Weight	24.3 kg

INTEGRATED AMPLIFIER

L-505uX II



The L-505uX Mark II is the eagerly awaited Mark II version of the popular L-505uX, a market leading integrated amplifier design since its launch in 2011. We have loaded it with proprietary technologies, such as version 4.0 of LUXMAN's ODNF (Only Distortion Negative Feedback), as well as LECUA (Luxman Electronically Controlled Ultimately Attenuator) and a discretely configured buffer circuitry for the pre-amp output, just like our flagship control amplifier, the C-900u. Polished with all our knowhow as a standard model beyond its class, the history of a long product run has just begun.

SPECIFICATIONS

Rated output	100 W+100 W (8 Ω) / 150 W+150 W (4 Ω)
Input sensitivity / impedance	PHONO (MM) 2.5 mV / 47 kΩ, PHONO (MC) 0.3 mV / 100 Ω, LINE 180 mV / 47 kΩ
Total harmonic distortion	0.009 % (1 kHz / 8 Ω), 0.09 % (20 Hz to 20 kHz / 8 Ω)
S/N ratio	LINE 104 dB or more
Frequency response	LINE 20 Hz to 100 kHz (within -3 dB)
Power consumption	300 W, 85 W (no signal), 0.4 W (at standby)
Dimensions	440 (W) x 178 (H) x 454 (D) mm
Weight	22.5 kg

CONTROL AMPLIFIER

C-900u



LUXMAN' s C-900u was created in our pursuit of superlative tonal quality. A fully balanced design with quality tone control is extremely difficult to implement but LUXMAN' s engineers have achieved this, allowing music lovers to enjoy the full range of their music collection. The balanced amplification circuitry, a four-module configuration, in which the hot & cold elements of the left & right audio signals are independently amplified, is introduced to suppress any unnecessary noise generation. The combination of our evolved ODNF version 4.0 circuitry and a robust power supply unit has achieved high S/N performance and improved sound quality without distortion. LUXMAN' s original fixed resistance switching type attenuator, the latest version of the New LECUA 1000 is used for the volume control system and is a major feature of this control amplifier.

SPECIFICATIONS

Input sensitivity / impedance	LINE 255 mV / 43 kΩ, BAL LINE 255 mV / 86 kΩ
Output voltage / impedance	LINE 1 V / 90 Ω, Maximum 11 V, BAL LINE 1 V / 180 Ω, Maximum 22.5 V
Total harmonic Distortion	LINE 0.009 % (20 Hz to 20 kHz), BAL LINE 0.005 % (20 Hz to 20 kHz)
Frequency response	20 Hz to 20 kHz (+0, -0.1 dB), 5 Hz to 120 kHz (+0, -3 dB)
S/N ratio	LINE 123 dB, BAL LINE 126 dB (Maximum output)
Power consumption	42 W, 2.2 W (at standby)
Dimensions	440 (W) x 130 (H) x 430 (D) mm
Weight	19.7 kg

STEREO POWER AMPLIFIER

M-900u



The M-900u stereo power amplifier has been created to bring out the best sound expression from any speaker system. A rich sonic gradient has been achieved, from deep bass to clear high tones, with sufficient driving power acquired by structurally connecting two quadruple-parallel push-pull output amplifier units. The updated version 4.0 of LUXMAN' s original ODNF circuit provides both a lively feeling and an ultra-low distortion characteristic. The M-900u is a flagship stereo amplifier, with its pure class A 12 Watts per channel (8Ω) and 150 Watts per channel (8Ω) or 600 Watts x 1 (8Ω) when used as a mono block. As a stereo amplifier, the M-900u is stable into a 1Ω load, where it delivers 1,200 Watts, peak power.

SPECIFICATIONS

Rated output	150 W+150 W (8 Ω) / Stereo, 300 W+300 W (4 Ω) / Stereo, 600 W (8 Ω) / Monaural
Maximum power output	1200 W+1200 W (1 Ω) / Stereo, 2400 W (2 Ω) / Monaural
Input sensitivity	1.24 V / 150 W (8 Ω)
Input impedance	LINE 51 kΩ, BAL LINE 34 kΩ
Total harmonic distortion	0.008 % or less (1 kHz / 8 Ω), 0.1 % or less (20 Hz to 20 kHz / 8 Ω)
Frequency response	20 Hz to 20k Hz (+0, -0.1 dB), 1 Hz to 130 kHz (+0, -3 dB)
S/N ratio	117 dB
Power consumption	540 W, 280 W (no signal), 1.0 W (at standby)
Dimensions	440 (W) x 224 (H) x 485 (D) mm
Weight	48.0 kg

VACUUM TUBE CONTROL AMPLIFIER

CL-1000



Wearing a beautiful rosewood-colored wooden case, the three-dimensional front face is made up of three aluminum panels and the finely processed knobs and levers have a unique presence with the suggestion of a vintage design. The combination of an electronically controlled, high-quality transformer equipped attenuator, named LECUTA*, and circuitry that uses highly reliable E88CC tubes, manufactured by JJ Electronic, has realized a fresh and abundant supreme harmony. The first stage and flat amplifier are P-K NF type, and the tone control amplifier is P-G NF type, which is a simple and highly reliable configuration that maximizes the characteristics of many carefully selected custom parts. It is a control amplifier that pursues the highest level in everything, even the modest knobs and switches, that bring a feeling of reliable operation.

*LECUTA : Luxman Electronically Controlled Ultimate Transformer Attenuator

SPECIFICATIONS

Input sensitivity / impedance	LINE 180 mV / 90 kΩ, BAL LINE 180 mV / 70 kΩ EXT-IN (PHONO) MM 2.2 mV / 100 kΩ, 50 kΩ, 33 kΩ MC-H 0.26 mV / 1 kΩ MC-M 0.26 mV / 40 Ω MC-L 87 μV / 10 Ω
Output voltage / impedance	LINE 1 V / 1 kΩ, Maximum 18 V BAL LINE 1 V / 1 kΩ, Maximum 18 V
Total harmonic Distortion	LINE / BAL LINE 0.016 % (1 kHz)
Frequency response	LINE / BAL LINE 20 Hz to 20 kHz (+0.3, -0 dB) EXT-IN (PHONO) 20 Hz to 20 kHz (±0.3 dB)
S/N ratio (for maximum output)	LINE / BAL LINE 120 dB EXT-IN (PHONO) MM 108dB, MC-H 92dB, MC-M 92dB, MC-L 83dB
Power consumption	52 W
Dimensions	460 (W) x 166 (H) x 454 (D) mm
Weight	24.4 kg

Electronically Controlled Transformer type Attenuator LECUTA

The heart of any preamplifier is the volume control. If not executed properly, this key circuit element can cause left/right channel imbalances and introduce subtle but tangible distortion at low volume. For this reason, LUXMAN created our acclaimed LECUA attenuator system. Now we've refined the concept with LECUTA, the Luxman Electronically controlled Ultimate Transformer Attenuator. The front panel volume control is actually a 34-step rotary switch that triggers 34 relays located totally outside the signal path. The relays activate 34 taps on matching left and right transformers. It is these taps that adjust the volume in carefully calibrated steps. Because transformer cores can influence sound quality, we selected FINEMET® core material from Hitachi Metals, Ltd. This has a unique nanocrystal structure for high saturation flux density, high relative permeability and low core loss. So you'll enjoy rich, detailed, uncompromising sound even at low volume.

*FINEMET is registered trademark of Hitachi Metals, Ltd.

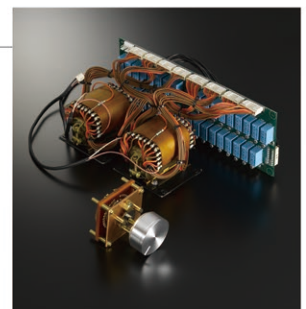

VACUUM TUBE CONTROL AMPLIFIER

CL-38uC



The CL-38uC retains the traditional look with its wooden case but the body width is now expanded to a LUXMAN standard size of 440 mm (the CL-38u had a width of 400 mm) and balanced inputs have been added, as our customers have requested. All vacuum tubes (ECC83S x 3, ECC82 x 5) are changed to JJ Electronic for the more reliable operation and Nichicon made high voltage metalized polypropylene film coupling capacitors have been introduced for a supple, natural tone.

SPECIFICATIONS

Input sensitivity / impedance	PHONO (MM) 2 mV / 47 kΩ, PHONO (MC high) 0.3 mV / 100 Ω, PHONO (MC low) 0.08 mV / 30 Ω, LINE 190 mV / 50 kΩ
Total harmonic distortion	0.006 % (1 kHz), 0.06 % (20 Hz to 20 kHz)
S/N ratio	PHONO (MM) 68 dB or more, PHONO (MC high) 63 dB or more, PHONO (MC low) 60 dB or more, LINE 100 dB or more
Frequency response	PHONO 20 Hz to 20 kHz (±0.5 dB), LINE 10 Hz to 70 kHz (Within -3 dB)
Power consumption	35 W
Dimensions	440 (W) x 169 (H) x 307 (D) mm
Weight	13.3 kg

VACUUM TUBE STEREO POWER AMPLIFIER

MQ-88uC



Launched as a matching complement to the CL-38uC, both the interior and exterior of the previous MQ-88u model has been upgraded, with many customizations, and reborn as the MQ-88uC. Equipped with KT-88 output tubes manufactured by JJ Electronic (Slovakia), known for their powerful and rich tone, running in triode mode. A beautiful dark brown finish has been adopted instead of black, as this new color beautifully matches the wooden cabinet. To enable more powerful reproduction with lower distortion, independent speaker terminals are provided for 4 Ω, 8 Ω and 16 Ω speakers.

SPECIFICATIONS

Rated output	25 W+25 W (4 Ω, 8 Ω, 16 Ω)
Input sensitivity / impedance	890 mV / 32 kΩ
Total harmonic distortion	0.1 % (1 kHz / 1 W), 0.5 % (20 Hz to 20 kHz / 1 W)
S/N ratio	105 dB
Frequency response	20 Hz to 20 kHz (+0, -0.2 dB), 10 Hz to 100 kHz (+0, -3 dB)
Power consumption	170 W, 140 W (no signal)
Dimensions	440 (W) x 184 (H) x 230 (D) mm
Weight	16.1 kg

*The product comes with a bonnet.

VACUUM TUBE INTEGRATED AMPLIFIER

LX-380



The LX-380 represents the 12th generation of our long running 38 series, launched with the SQ-38 in 1963. Our original high-clarity, electronically controlled attenuator, LECUA, is now incorporated into a vacuum tube amp for the first time in a traditional design, combining a wooden cabinet with a full size 440mm front panel. In the power section, the Mullard type driver stage and the push-pull configured 6L6GC output tubes demonstrate their reputation for delicate, soft tones in this application. The excellent semiconductor circuitry and control system which comprises the first stage of this great unit ensures high performance and long-term stability. The latest technology exquisitely combines with traditional know-how and a musical, rich tube output brings out the enthusiast-focused attraction of this hybrid tube-loaded integrated amplifier.

SPECIFICATIONS

Rated output	20 W+20 W (6 Ω) / 18 W+18 W (8 Ω) / 14W+14W (4 Ω)
Input sensitivity / impedance	PHONO (MM) 3.0 mV / 47 kΩ, PHONO (MC) 0.38 mV / 100 Ω, LINE 180 mV / 47 kΩ
Total harmonic distortion	1 % (1 kHz / 6 Ω)
S/N ratio	LINE 95 dB or more
Frequency response	LINE 20 Hz to 80 kHz (within -3 dB)
Power consumption	127 W
Dimensions	440 (W) x 197 (H) x 403 (D) mm
Weight	17.6 kg

VACUUM TUBE CD PLAYER

D-380



As the successor to the D-38u, a long-selling product since its launch in 2009, the D-380, in its traditional wooden case, has evolved, featuring a switching function which can select either solid state or vacuum tube output circuitry. The ECC82-loaded vacuum tube output stage is equipped with a large output transformer and dedicated filter circuitry. For the digital circuitry, newly introduced Texas Instruments jitter reduction ICs have been introduced. The core processors are Texas Instruments 32 bit compatible PCM5102A DAC chips. Furthermore, by improving the drive mechanism and the chassis structure, we improved the basic mechanical performance as a dedicated CD player, while acquiring a density of expression unique to a vacuum tube output stage.

SPECIFICATIONS

Supported media	CD, CD-R, CD-RW
Analog output	LINE x 1
Digital output	Coaxial x 1, Optical x 1
Output voltage / impedance	Solid state 2.1 V / 300 Ω, Vacuum tube 2.4 V / 300 Ω
Frequency response	Solid state 20 Hz to 20 kHz (+0, -0.2 dB), Vacuum tube 20 Hz to 20 kHz (+0.1, -0.3 dB)
Total harmonic distortion	Solid state 0.005 %, Vacuum tube 0.8 %
S/N ratio	Solid state 115 dB, Vacuum tube 105 dB
Power consumption	16 W
Dimensions	440 (W) x 167 (H) x 286 (D) mm
Weight	10.8 kg



BELT DRIVE ANALOG PLAYER

PD-151



LUXMAN's latest turntable, the PD-151 is a belt drive analog player with an advanced fusion of design and functionality. By reproducing the basic design structure of the well-established PD-171A, we have gone forward, while maintaining that model's level of quality. The universal tone arm is the same as the PD-171A, hence it is easy to substitute the listener's favored cartridge, enabling the enjoyment of specific tonal qualities. The newly designed, high precision, highly reliable DC brushless motor took two years to develop and provides true 78rpm playback adjustable, delivering accurate rotation with high torque. The PD-151 is a satisfying standard model that makes full range analog playback a close and comforting experience.

SPECIFICATIONS

Phono motor section

Drive system	Belt drive system
Motor	PID controlled DC brushless motor
Materials	Machined aluminum, diamond cut surface
Revolution	33 1/3 rpm, 45 rpm, 78 rpm (3 speeds selectable)
Revolution adjustment range	±6 % (each rotation speed adjustable independently)
Wow and flutter	0.04 % (W.R.M.S.) or less
Weight	4.0 kg (platter)

Tone arm section

Type	Static balanced, S shaped
Bearing	Single point cross suspension
Effective length	229 mm
Overhang	15 mm
Tracking error angle	+1.9° to -1.1°
Suitable cartridge weight	4 to 12 g (Including head shell 17 to 25 g)
Adjustable height range	38 to 60 mm
Anti-skating bias	0 to 3 g

Body

Power consumption	6 W
Dimensions	465 (W) x 133 (up to top face of platter) (H) x 393 (D) mm
Weight	15.7 kg

*Dust cover is sold separately

Accessories for PD-171A / PD-171AL / PD-151

Arm Base

● **OPPD-AB1**
OPPD-AB1 for SME3009R / 3010R and other 9 inch, 10 inch tonearms

PD-171A **PD-171AL**

● **OPPD-AB2**
OPPD-AB2 for FR64 / 64S / 64FX IKEADA IT-345

PD-171A **PD-171AL**

● **OPPD-AB3**
OPPD-AB3 for SAEC WE-308

PD-171A **PD-171AL**

● **OPPD-AB4**
OPPD-AB4 for SAEC WE-407/23

PD-171A **PD-171AL**

● **OPPD-AB5**
OPPD-AB5 for ORTOFON AS-212S / RS-212D

PD-171A **PD-171AL**

● **OPPD-AB6**
OPPD-AB6 for DIY universal tonearm base

PD-171A **PD-171AL**

Heavy counterbalance weight

● **OPPD-HW1**
For cartridges of 9 to 19 g (22 to 32 g including headshell)

PD-171A **PD-151**

Headshell

● **OPPD-SH1**
Light magnesium alloy, 13 g (including wires)

PD-171A **PD-151**

Rubber drive belt

PD-171A **PD-171AL** **PD-151**

Dust cover

● **OPPD-DSC151**
Specific to the PD-151, 4mm thick acrylic, cam support hinges

PD-151

*PD-171A / PD-171AL are out of production.

VACUUM TUBE PHONO AMPLIFIER

EQ-500



The EQ-500 CR type equalizer evokes excellent tone, supported by its linear characteristics without the need for feedback and its quality features, reproducing the living breath of music unique to analog record playback. This model uses vacuum tubes in each crucial section. The front panel lay out features many useful adjustment controls and switching functions according to the listener's choice of cartridge, aiming to display a practical presence and functional beauty.

SPECIFICATIONS

Circuiting system	SRPP, final stage cathode follower, non-feedback CR type equalizer (RIAA)
Input sensitivity / impedance	MM 4 mV / 30 kΩ to 100 kΩ (variable), MC high 0.44 mV / 40 Ω, MC low 0.18 mV / 2.5 Ω
Gain	MM 36 dB, MC high 55 dB, MC low 63 dB *Input sensitivity and gain at 36dB gain switching
Output voltage / impedance	250 mV / 850 Ω
S/N ratio	MM 76 dB, MC high 75 dB, MC low 74 dB
Power consumption	47 W
Dimensions	440 (W) x 92 (H) x 397 (D) mm
Weight	12.5 kg

PHONO AMPLIFIER

E-250



The E-250 allows the listeners to fine tune settings for any recorded performance, releasing the expression engraved in the grooves of vinyl discs and creating a hitherto unknown musical impression. The rear panel is equipped with an impedance selector and a load capacity selector to match the characteristics of the selected cartridge, exploiting the output to its full potential. The E-250 features a step up transformer with a 2 stage gain sector with independent left and right circuits. The super permalloy core supports even low impedance MC cartridges. This creates a rich and expressive musicality that is a unique characteristic of this type of transformer.

SPECIFICATIONS

Circuiting system	NF type equalizer (RIAA)
Input sensitivity / impedance	MM 3.2 mV / 34 kΩ, 47 kΩ, 56 kΩ, 100 kΩ (switchable), MC high 0.37 mV / 40 Ω, MC low 0.12 mV / 2.5 Ω
Gain	MM 38 dB, MC high 57 dB, MC low 66 dB
Output voltage / impedance	250 mV / 300 Ω
S/N ratio	MM 90 dB, MC high 83 dB, MC low 80 dB
Power consumption	7 W
Dimensions	364 (W) x 81 (H) x 274 (D) mm
Weight	4.3 kg

SUPER AUDIO CD PLAYER

D-10X

NEW



The D-10X features our new LxDTM-I original disk transport mechanism, ROHM's high spec BD3430EKV DAC chips running in dual monaural mode, fully discrete analog circuitry and our latest version of ODNF-u, defining it as a flagship model SACD player. Digital data is read with high accuracy due to our LxDTM-i mechanism, with increased rigidity and traditional stability, the player exhibits the latest digital circuitry that supports PCM data up to 768kHz / 32-bit and DSD data up to 22.4 MHz / 1bit. Digital signals are converted to analog and the source information is reproduced with rich musicality and expressiveness, further enhanced by fully balanced discrete amplifier circuitry. In addition, full decoding of MQA-CD and MQA files is also supported, enabling high-quality playback for diversified digital audio sources.

SPECIFICATIONS

Supported media	SACD, CD, CD-R, CD-RW, MQA-CD
Analog output	LINE x 1, BAL LINE x 1
Supported sampling frequency	USB input (PCM) 44.1 kHz, 48 kHz, 88.2 kHz, 96 kHz, 176.4 kHz, 192 kHz, 352.8 kHz, 384 Hz, 705.6 Hz, 768 Hz (16, 24, 32 bit) USB input (DSD) 2.8 MHz, 5.6 MHz, 11.2 MHz, 22.4 MHz (1bit) COAX / OPT input 44.1 kHz, 48 kHz, 88.2 kHz, 96 kHz, 176.4 kHz, 192 kHz (16, 20, 24 bit)
Digital input	USB (Type-B) x 1, COAX x 1, OPT x 2
Digital output	COAX x 1, OPT x 1
Output voltage / impedance	LINE 2.4 V / 300 Ω, BAL LINE 2.4 V / 600 Ω, SACD / DSD 1.3V
Frequency response	CD 5 Hz to 20 kHz (+0, -1 dB), SACD 5 Hz to 38 kHz (+0, -3 dB), USB 5 Hz to 47 kHz (+0, -3 dB)
Total harmonic distortion	CD 0.0018 %, SACD 0.001 %, USB 0.0015 %
S/N ratio	CD 125 dB, SACD 121 dB, COAX / OPT 125 dB, USB 125 dB
Power consumption	48 W, 1 W (standby)
Dimensions	440 (W) x 154 (H) x 418 (D) mm
Weight	22.4 kg

*LUXMAN Audio Player or the driver software is available for download on our website.

CD PLAYER

D-03X

NEW



The D-03X is equipped with a highly reliable, dedicated CD transport mechanism to improve accuracy, provide stable operation and reduce noise when reading discs. It delivers high quality amplification via fully balanced output circuitry. The D/A converter features dual Texas Instruments PCM 1795 chips to handle high resolution files. The USB input supports PCM data up to 384 kHz / 32-bit and DSD files up to 11.2 MHz / 1 bit with high precision signal processing. In addition, the newly supported Bulk Pet transfer has expanded the options for high-quality and stable file playback by reducing load between sender and receiver. Increasing numbers of titles feature MQA-CD / MQA encoded files are fully supported. Both CD playback, which is still at the center of listener's collections, and diversified digital file / data playback can be achieved with high quality.

SPECIFICATIONS

Supported media	CD, CD-R, CD-RW, MQA-CD
Analog output	LINE x 1, BAL LINE x 1
Supported sampling frequency	USB input (PCM) 44.1 kHz, 48 kHz, 88.2 kHz, 96 kHz, 176.4 kHz, 192 kHz, 352.8 kHz, 384 Hz (16, 24, 32 bit) USB input (DSD) 2.8 MHz, 5.6 MHz, 11.2 MHz (1bit) COAX / OPT input 44.1 kHz, 48 kHz, 88.2 kHz, 96 kHz, 176.4 kHz, 192 kHz (16, 20, 24 bit)
Digital input	USB (Type-B) x 1, COAX x 1, OPT x 1
Digital output	COAX x 1, OPT x 1
Output voltage / impedance	LINE 2.4 V / 300 Ω, BAL LINE 2.4 V / 600 Ω, DSD 1.7 V
Frequency response	CD 5 Hz to 20 kHz (+0, -1 dB), COAX / OPT / USB 5 Hz to 47 kHz (+0, -3 dB)
Total harmonic distortion	CD 0.003 %, COAX / OPT / USB 0.002 %
S/N ratio	CD 101 dB, COAX / OPT 114 dB, USB 113 dB
Power consumption	18 W
Dimensions	440 (W) x 133 (H) x 410 (D) mm
Weight	13.2 kg

*LUXMAN Audio Player or the driver software is available for download on our website.

LUXMAN original music playback software

LUXMAN has developed an original music playback software system, LUXMAN Audio Player. It is a bespoke software player, providing high quality audio playback over USB on both Windows PC and Mac. This software can handle the regular formats used by major distribution sites such as FLAC, ALAC, WAV, AIFF, MP3 and DFS / DSDIFF.



LUXMAN Audio Player

Neo Classico II

Return home to a space filled with beautiful sound

The NeoClassico series has returned after 11 years.

We present the combination of a high quality vacuum tube pre-main amplifier, the SQ-N150 and the D-N150 CD player, equipped with a USB input, in a compact A4 footprint design.

In combination with high-performance compact speakers, you will discover new dimensions to the music you've been listening to.

A realistic sound stage will appear before your ears.

It will be a pleasure to fill your living space with such rich sound quality, creating a truly satisfying listening experience.

We celebrate the long awaited return of the revamped Neo Classico series.

VACUUM TUBE INTEGRATED AMPLIFIER

SQ-N150



The NeoClassico series returns after 11 years, featuring this compact and stylish A4 sized integrated amplifier with an attractive level of audio quality. This vacuum tube integrated amplifier is the core of the series. It has undergone a complete transformation, with newly designed components suitable for a high-end model, while staying true to the original concept. Simplified circuitry, utilizing EL84 vacuum tubes in a push-pull configuration, produces an output of 10W per channel, placing importance on enjoying this unit's excellence for a long time. Improvements, including the addition of a new analog level meter, balance adjustment and MC cartridge input, further enhance this complete integrated amplifier.

SPECIFICATIONS

Rated output	10 W+10 W (6 Ω)
Input sensitivity / impedance	PHONO (MM) 3.0 mV / 47 kΩ, PHONO (MC) 0.33 mV / 100 Ω, LINE 180 mV / 47 kΩ
Total harmonic distortion	1 % or less (1 kHz / 6 Ω)
S/N ratio	LINE 95 dB or more
Frequency response	LINE 20 Hz to 80 kHz (within -3 dB)
Power consumption	98 W
Dimensions	297 (W) x 188 (H) x 251 (D) mm
Weight	12.4 kg

*The product comes with a bonnet.

CD PLAYER

D-N150



The D-N150 CD player, a matching complement to the SQ-N150, is equipped with Texas Instruments PCM5102A DAC chips, which can handle audio encoding up to 192 kHz/32 bit, and a highly reliable LUXMAN transport mechanism, known for stable and accurate disc reading, featured in our D-380 CD player. Newly equipped with coaxial, optical and USB terminals for digital inputs, it can also be used as a digital audio hub. The remote control allows player control and amplifier volume adjustment. The NeoClassico II series suspends time by relaxing and immersing the listener in the music with favorably designed and truly enjoyable products.

SPECIFICATIONS

Supported media	CD, CD-R, CD-RW
Analog output	LINE x 1
Supported sampling frequencies	USB input (PCM) 32 kHz, 44.1 kHz, 48 kHz, 88.2 kHz, 96 kHz, 176.4 kHz, 192 kHz (16, 24, 32 bit), COAX / OPT input (PCM) 32 kHz, 44.1 kHz, 48 kHz, 88.2 kHz, 96 kHz, 176.4 kHz, 192 kHz (16,20,24 bit)
Digital input	USB x 1, COAX x 1, OPT x 1
Digital output	OPT x 1
Frequency response	CD 5 Hz to 20 kHz (+0, -0.5 dB), COAX / OPT / USB 5 Hz to 50 kHz (+0, -3 dB)
Total harmonic distortion	CD 0.005 %, COAX / OPT / USB 0.005 %
S/N ratio	CD 110 dB, COAX / OPT / USB 110 dB
Power consumption	13 W
Dimensions	297 (W) x 98 (H) x 222 (D) mm
Weight	5.0 kg

*LUXMAN Audio Player or the driver software is available for download on our website.

SYSTEM SELECTOR

Switch the system and enjoy comparing the expressions of music. This is a series of high-definition system selectors to enable enjoyment of the epitome of audio. In order to avoid noise through the circuit loop, LUXMAN, striving for sound quality, introduces switching for each ground line, adopting highly pure gold-plated terminals, and discrete wiring. Furthermore, 6N (99.99997% copper) wire is used for the wiring material in the AS-44 and AS-55, and it is composed of a grade suitable for a high-end separate amplifier. In addition, the latest refined models of the long-selling AS-4/AS-5, AS-4(III) and AS-5(III) models have an additional index space to further improve usability. The AS-50R sees the introduction of a remote control, allowing you to comfortably switch between multiple systems while in the listening position.

AS-44 4-LINE RCA TERMINAL TYPE COAXIAL LINE SELECTOR

The AS-44 is a passive, high-quality audio selector that can switch up to four audio devices over an RCA network. To match high-end separate amplifiers, the unit is of the highest quality, with a highly rigid aluminum housing. All the internal wiring is 6N (99.99997% pure) copper wire, purity retains quality and prevents information loss. The RCA terminals are also plated with highly pure gold. There is no compromise in sound quality considerations. This unit can be used as a source selector for switching between CD players, tuners, and D/A converters, or as an amplifier selector that switches and shares one source with multiple amplifiers.

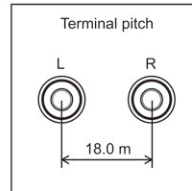
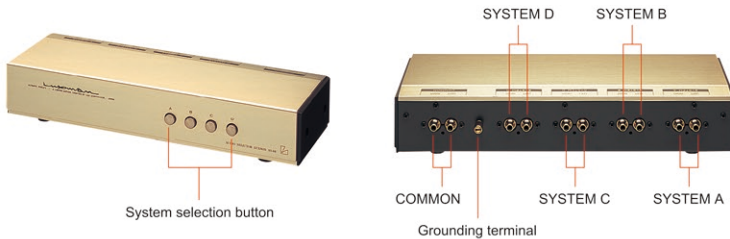

SPECIFICATIONS

Dimensions	370 (W) x 71 (H) x 136 (D) mm
Weight	2.4 kg

AS-55 3-LINE SPEAKER TERMINAL TYPE SPEAKER SELECTOR

The AS-55 is a speaker terminal type, passive, high-quality audio selector that can switch between three speaker outputs. The high quality construction matches high-end separate amplifiers, with a highly rigid aluminum housing, 20 A rotary switch to select output signals and 6N (99.99997% pure) copper wire used for internal connections. Bare wire, spade or banana plugs can be connected to these high grade speaker output terminals. Using this unit enables the listener select between three amplifier inputs for three separate speaker systems.

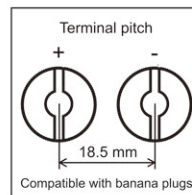

SPECIFICATIONS

Dimensions	370 (W) x 71 (H) x 164 (D) mm
Weight	3.0 kg
Speaker terminal Supported Y-lug terminal dimension	
Width of part a :	17 mm or less
Width of part b :	8 mm or more



* Connection may not be performed depending on the shape of the Y-lug terminal.

AS-50R 3-LINE SPEAKER TERMINAL TYPE SPEAKER SELECTOR

The AS-50R is a speaker terminal type audio selector which enables switching between three speaker outputs and also supports remote control operation. Switching is made possible by using a 5 A, high capacity speaker relay that is discretely controlled by the main unit or the included remote control. You can switch between multiple systems comfortably while in your listening position. By changing the ID setting of the main unit, up to four AS-50Rs can be operated with one remote control, and it is possible to build an advanced system that can select multiple speakers and amplifiers in all directions.

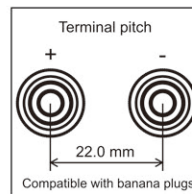
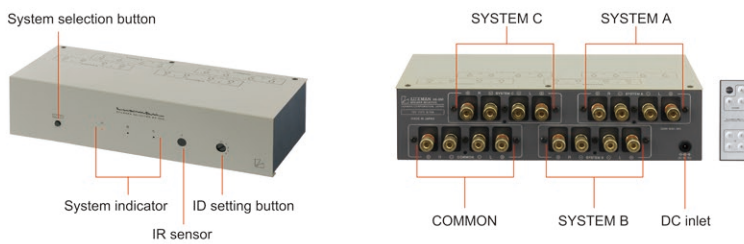

SPECIFICATIONS

Dimensions	297 (W) x 75 (H) x 120 (D) mm
Weight	1.8 kg
Speaker terminal Supported Y-lug terminal dimension	
Width of part a :	22 mm or less
Width of part b :	8 mm or more

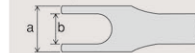

* Connection may not be performed depending on the shape of the Y-lug terminal.

*An AC adapter is required to operate this unit.

AS-4(III) RCA TERMINAL TYPE COAXIAL LINE SELECTOR

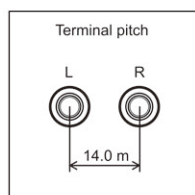
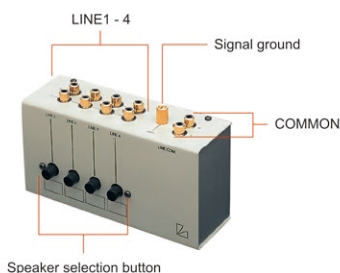

SPECIFICATIONS

Dimensions	160 (W) x 65 (H) x 95 (D) mm
Weight	530 g

AS-5(III) SPEAKER TERMINAL TYPE CHANNEL SELECTOR

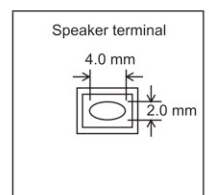

SPECIFICATIONS

Dimensions	240 (W) x 65 (H) x 95 (D) mm
Weight	750 g

AUDIO CABLE / ULTIMATE 15000 SERIES

LUXMAN's ultimate 15000 series features three different high-grade genuine audio cables which have been engineered utilizing a wide range of break-through technologies and know-how gained from decades of experience developing class leading audio amplifiers. The 15000 series has a well-established strand configuration, with its unique non-twisted structure, established in our previous cable series, and extremely pure 7N-Class D.U.C.C. copper core wire which possesses very low impedance. With the newly developed movable branch holder, it's now possible to have a longer cable branch without compromising its performance and appearance, which was difficult due to the integral structure of our previous cables. This is a true flagship reference cable that brings out an extended special silence and density of sound when driven, allowing system components to perform at their best.

*D.U.C.C.(Dia-Ultra Crystallized Copper) is the registered trademark of Mitsubishi Cable Industries., Ltd.
 *Our JPR/JPC-15000 is made from 100 % 7N-Class D.U.C.C. copper and the JPS-15000 is made from 60 % 7N-Class D.U.C.C. copper and 40 % OFC copper.



JPC-15000

1.3 m cable with XLR connectors
 7N-Class D.U.C.C.
 (99.99998 % OFC) conductor



JPS-15000

3.0 m speaker cable with spade plugs
 7N-Class D.U.C.C.
 (99.99998 % OFC) conductor
 + OFC conductor



JPR-15000

1.3 m cable with RCA connectors
 7N-Class D.U.C.C.
 (99.99998 % OFC) conductor

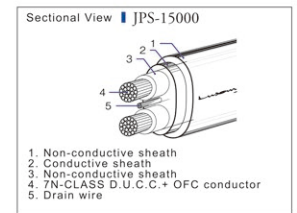
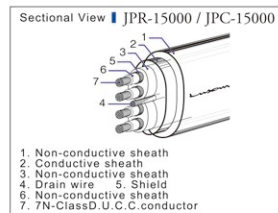

AUDIO CABLE / ULTIMATE 10000 SERIES



JPC-10000

1.25 m cable with XLR connectors
 6N (99.99997 % Copper)
 high-grade conductor



JPR-10000

1.25 m cable with RCA connectors
 6N (99.99997 % Copper)
 high-grade conductor

AUDIO CABLE / REFERENCE SERIES



JPC-150

1.5 m cable with XLR connectors
 Oxygen Free Copper (OFC) conductor

JPC-100

1.0 m cable with XLR connectors
 Oxygen Free Copper (OFC) conductor



JPS-100

50 m speaker cable reel
 Oxygen Free Copper (OFC) conductor



JPR-150

1.5 m cable with RCA connectors
 Oxygen Free Copper (OFC) conductor

JPR-100

1.0 m cable with RCA connectors
 Oxygen Free Copper (OFC) conductor



JPU-150

1.5 m USB 2.0 cable
 Oxygen Free Copper (OFC) conductor

TERMINAL PLUG



JPB-10

Banana plug (4 plugs, boxed)
 Solid carved brass
 24 K gold plated



JPY-10

Spade plug (4 plugs, boxed)
 Solid carved brass
 24 K gold plated



* Specifications and appearance are subject to change without notice. * The products listed in this catalog do not include line cables. Please purchase cables separately.

LUXMAN

LUXMAN CORPORATION, 1-3-1 Shinyokohama, Kouhoku-ku, Yokohama-shi, Kanagawa 222-0033, Japan
Tel: +81-45-273-5286 Fax: +81-45-470-6997 www.luxman.com

LUXMAN reserves the right to alter the design and specifications without notice.
All rights reserved LUXMAN CORPORATION



Safety Cautions

To ensure correct use of this product, read the "Owner's Manual" prior to use. Failure to follow all safeguards can result in fire, electric shock, or other accidents.